

Electronically Controlled Transmission and A/T Indicator

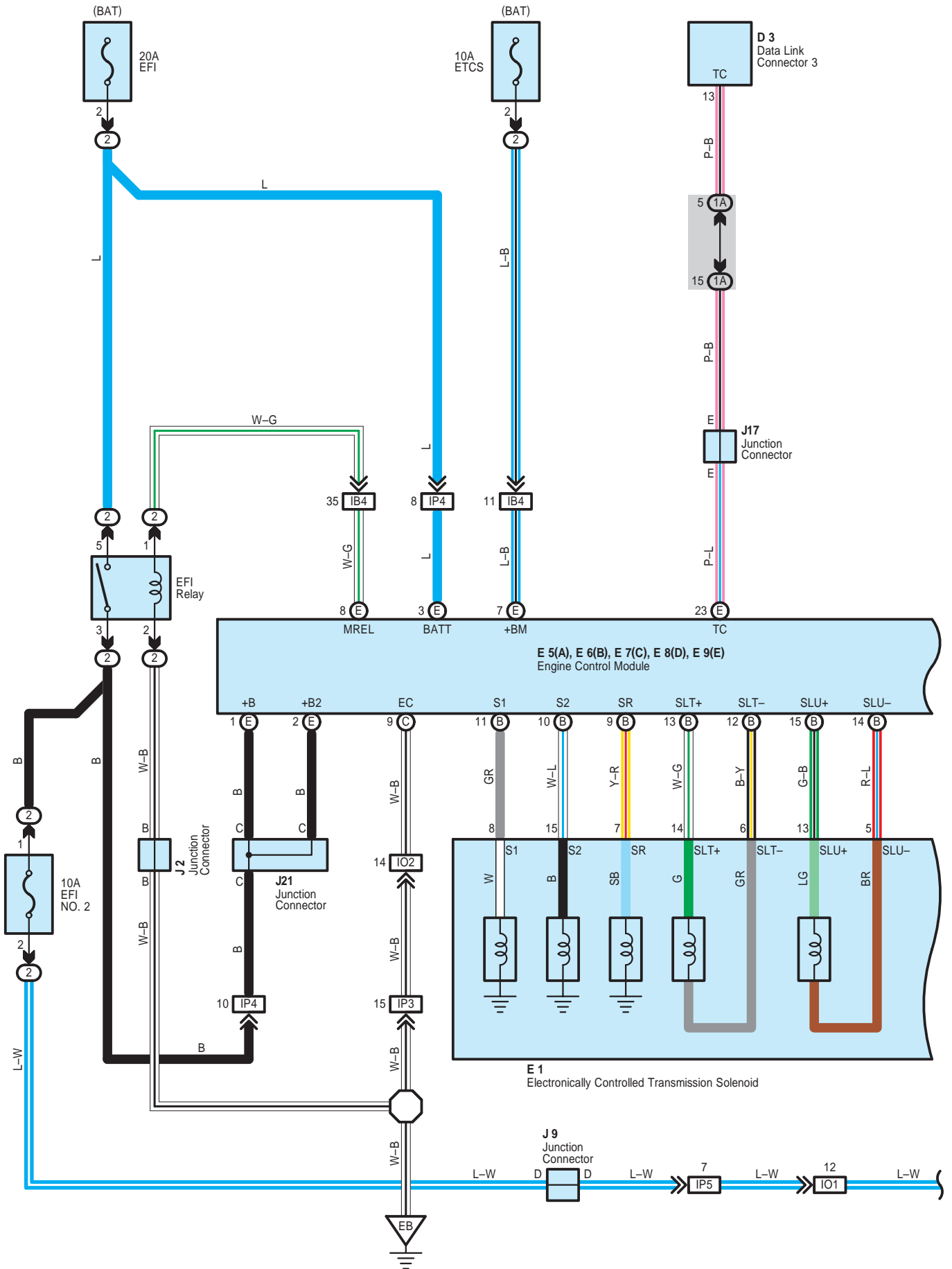

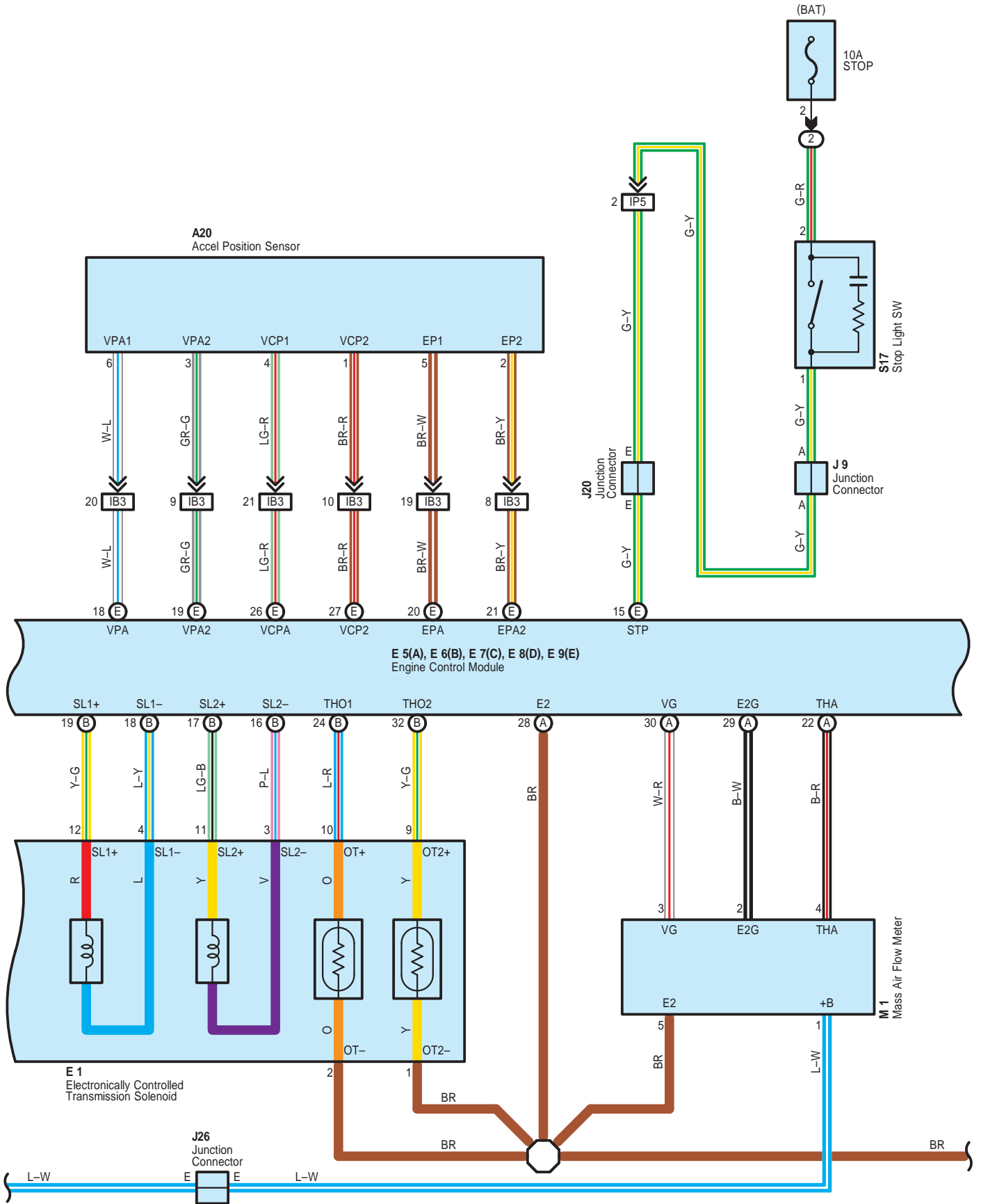

Electronically Controlled Transmission and A/T Indicator

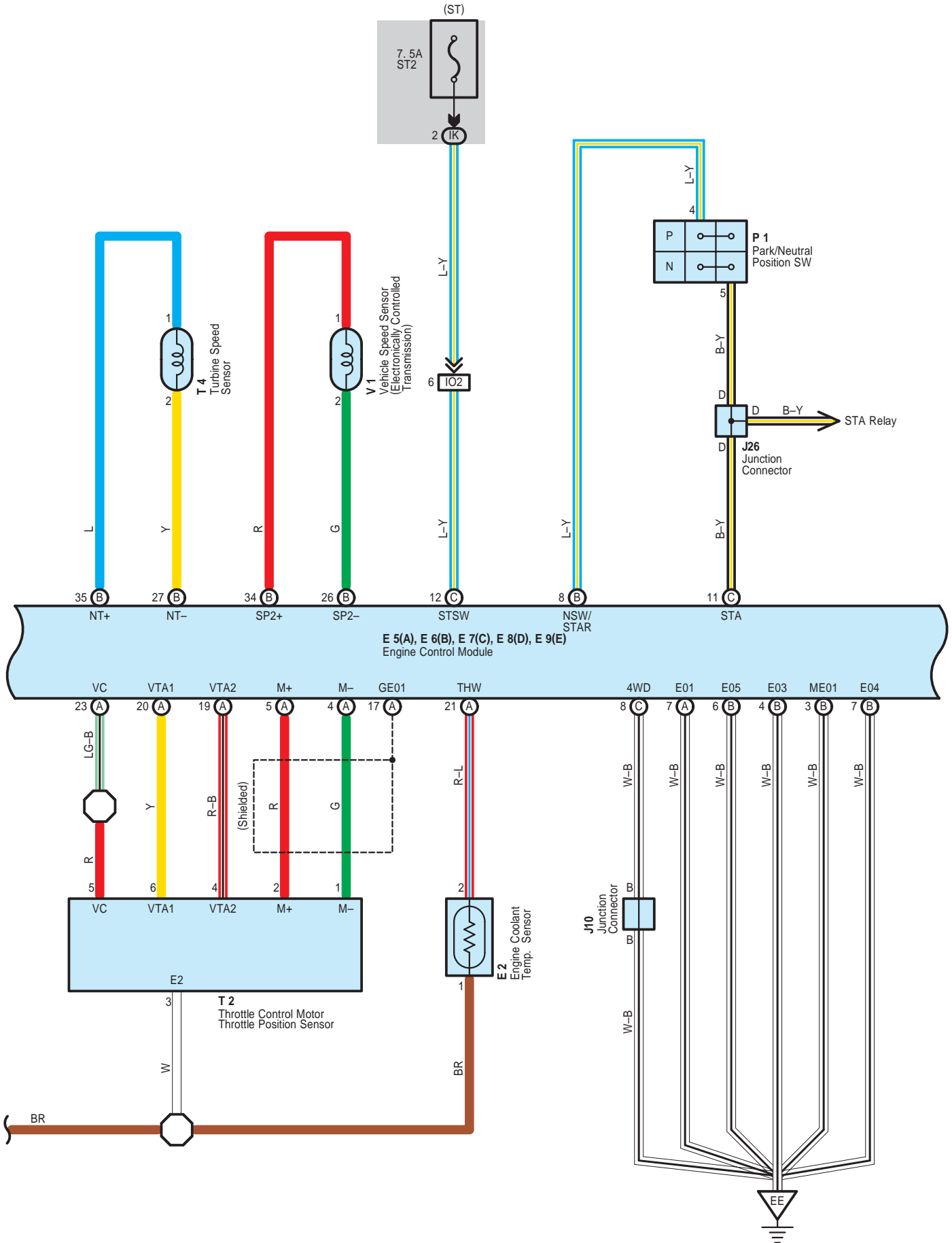

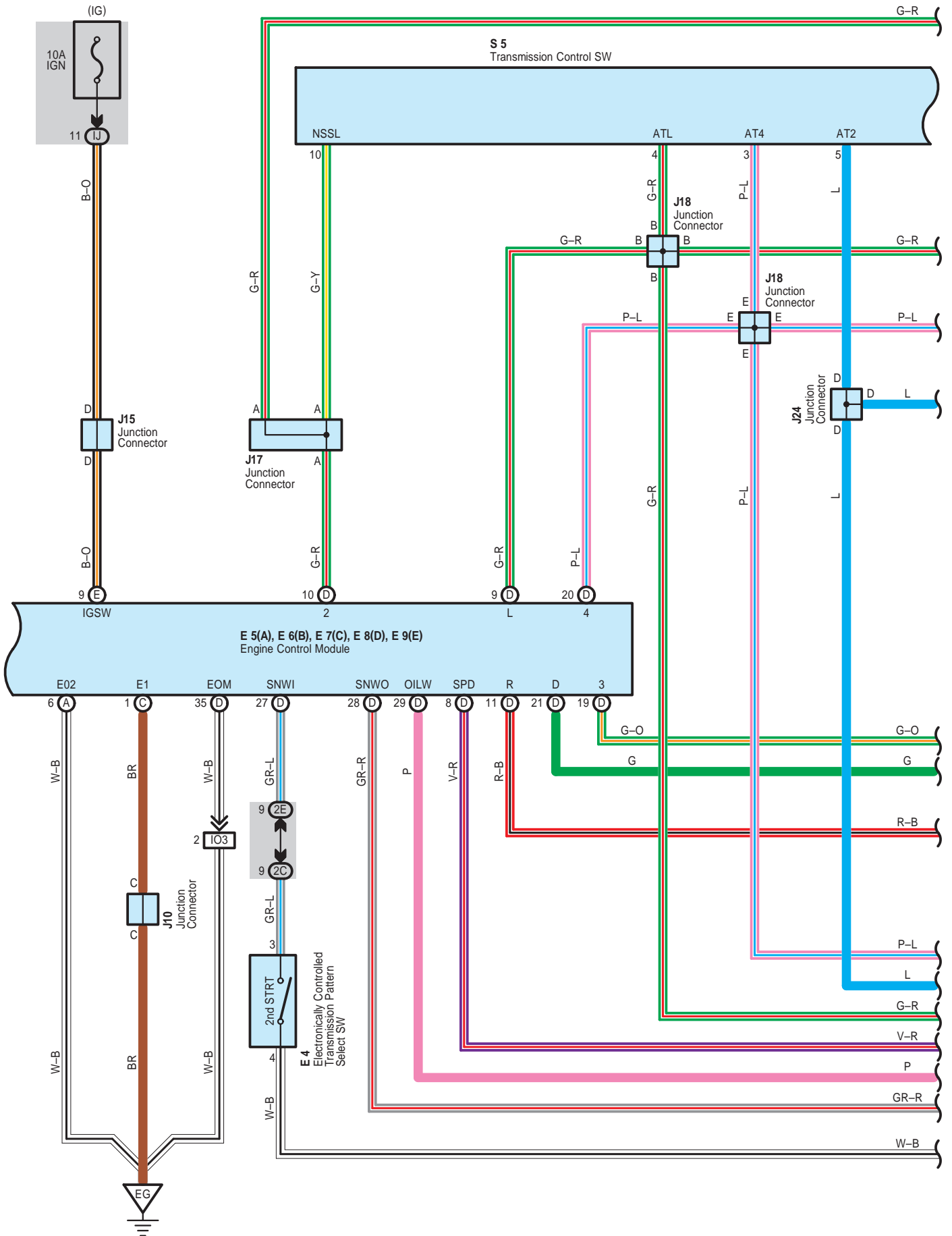

Electronically Controlled Transmission and A/T Indicator

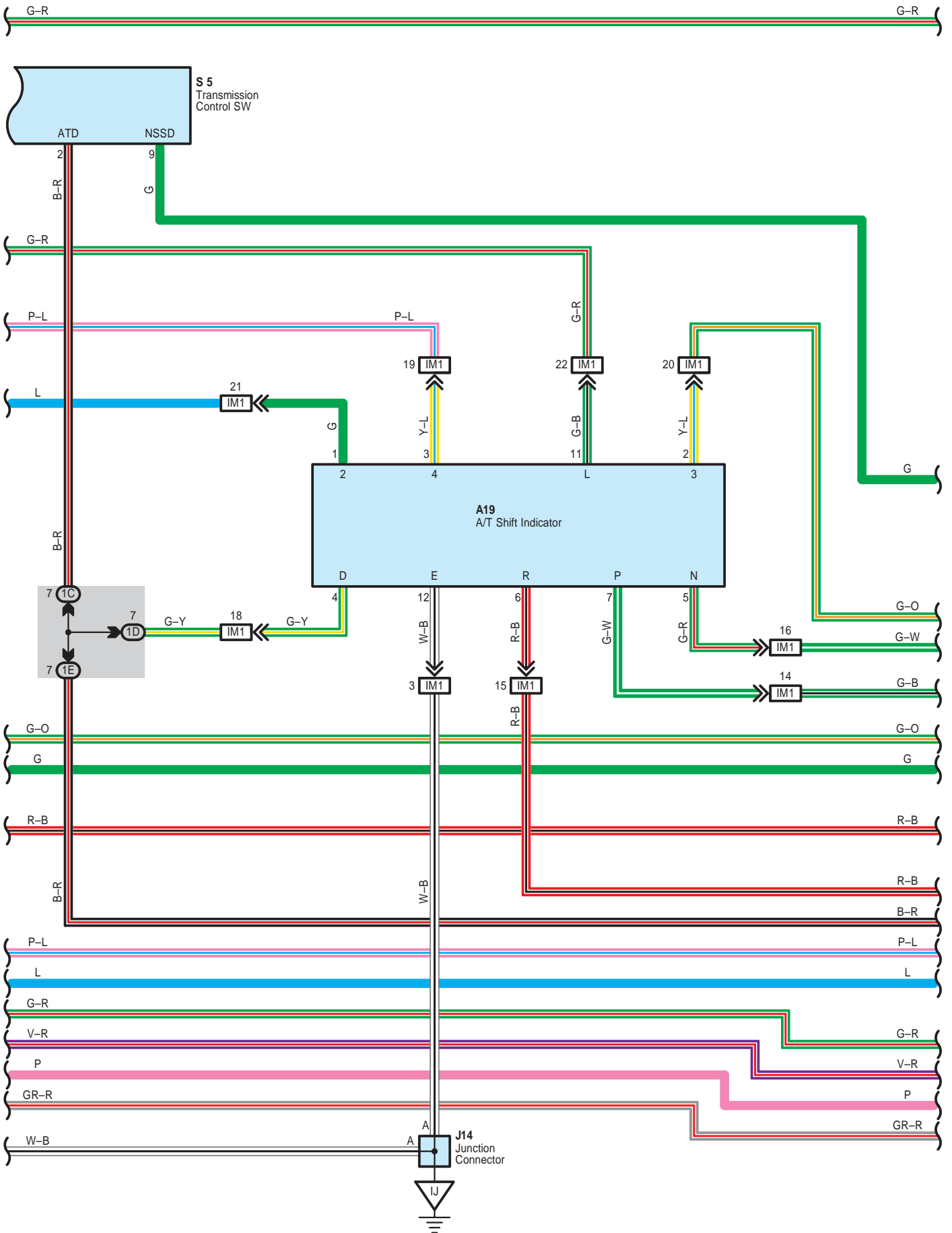

Electronically Controlled Transmission and A/T Indicator

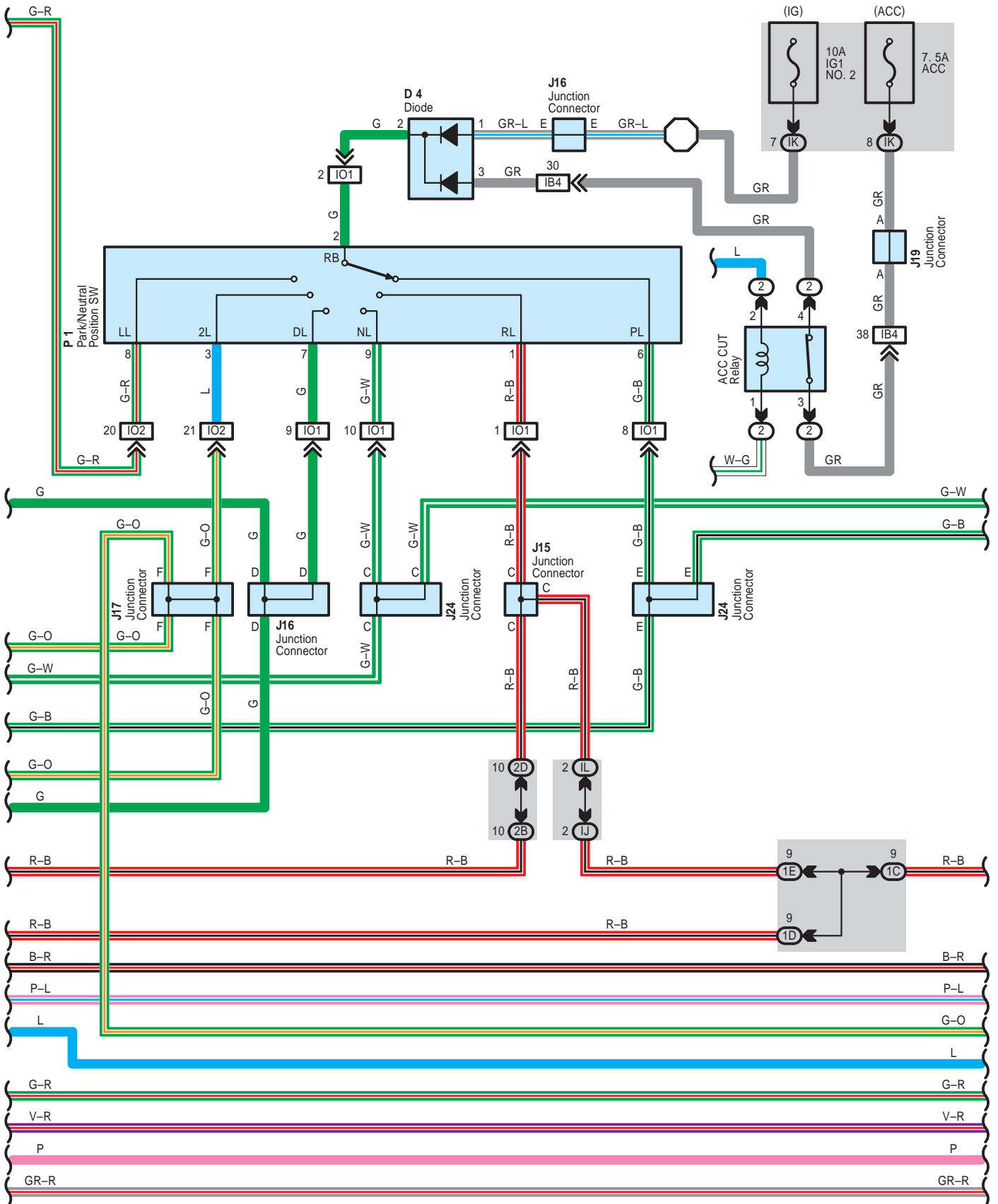

Electronically Controlled Transmission and A/T Indicator

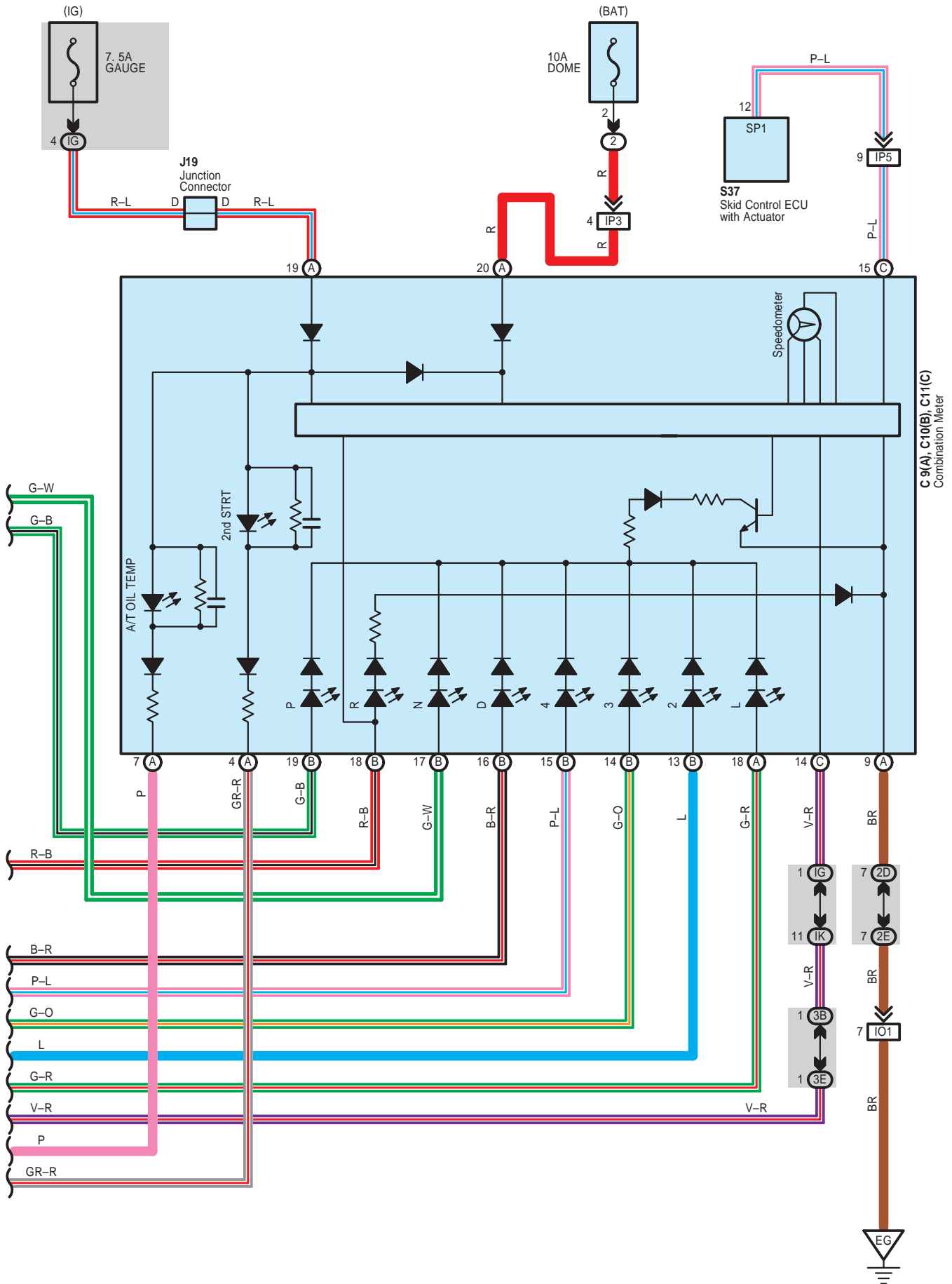

Electronically Controlled Transmission and A/T Indicator

A 19
White

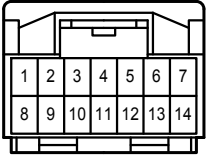

A 20
Black

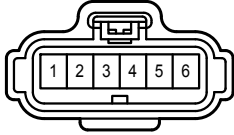

C 9
White

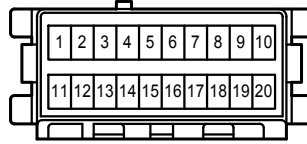

C 10
White

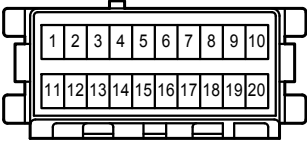

C 11
White

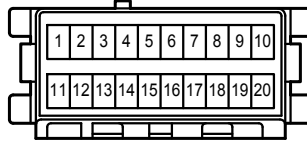

D 3
White

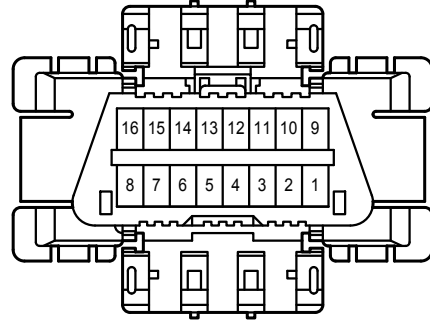

D 4
Gray

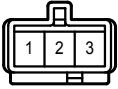

E 1
Gray

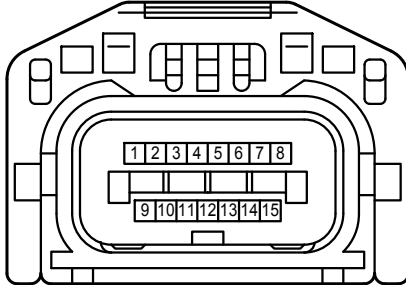

E 2
Dark Gray



E 4
Gray

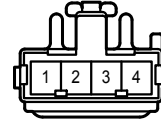

E 5
White

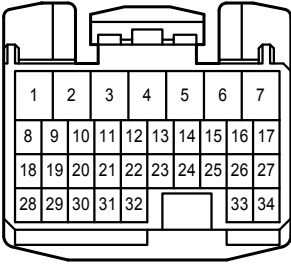

E 6
White

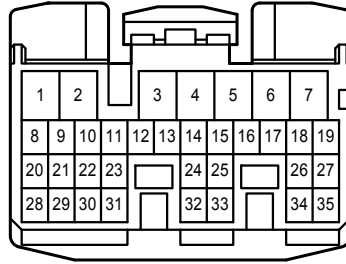

E 7
White

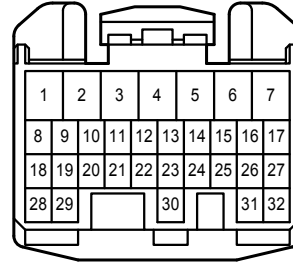

E 8
White

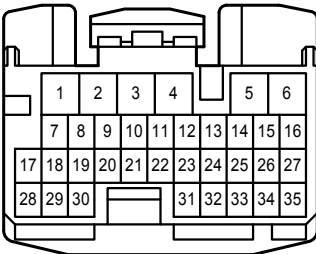

E 9
White

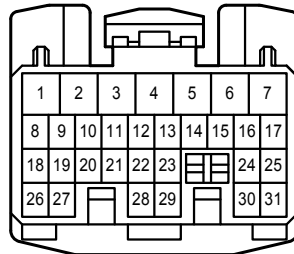

J 2
Blue

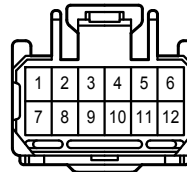

Electronically Controlled Transmission and A/T Indicator

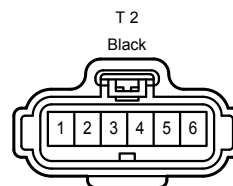
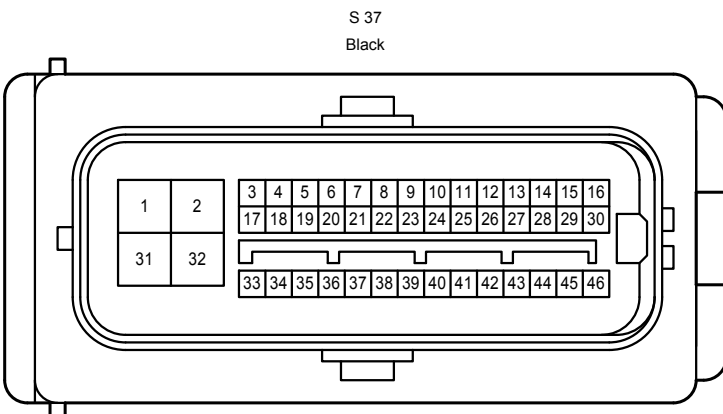
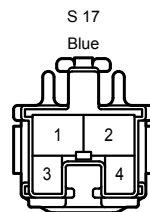
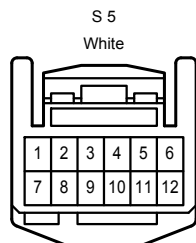
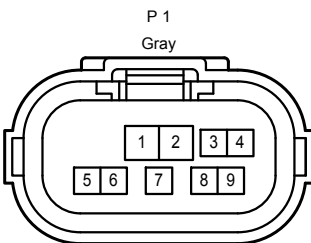
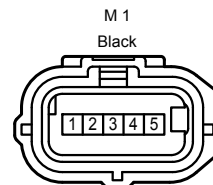
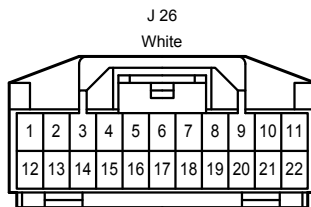
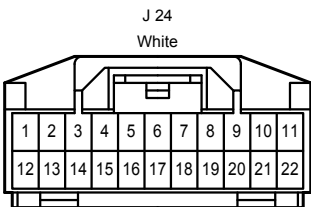
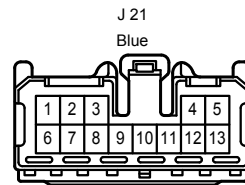
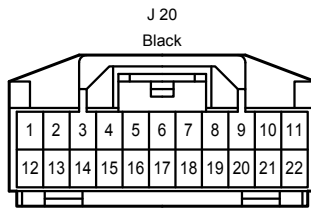
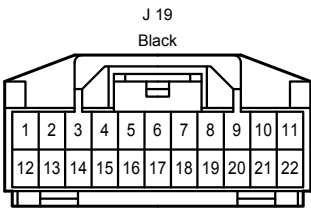
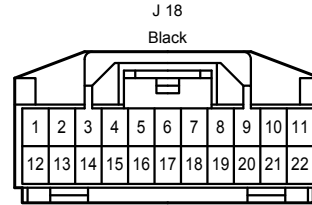
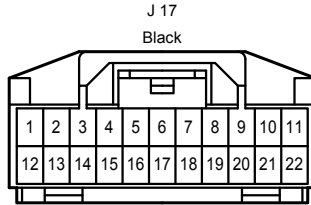
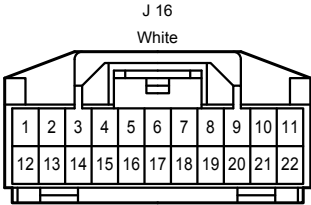
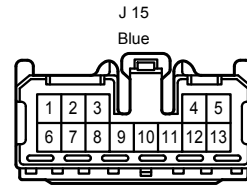
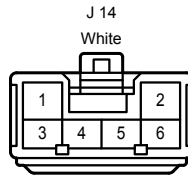
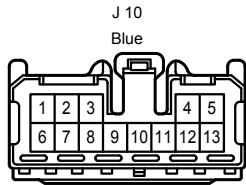
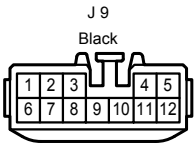

Electronically Controlled Transmission and A/T Indicator

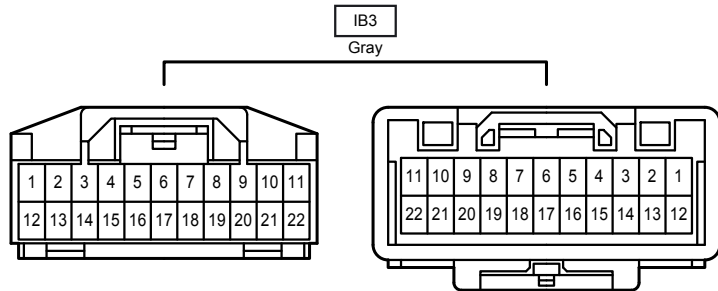
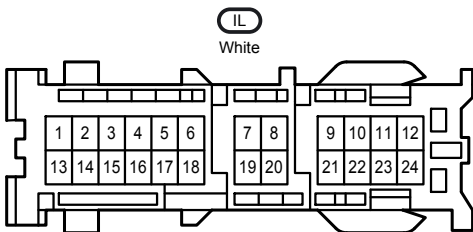
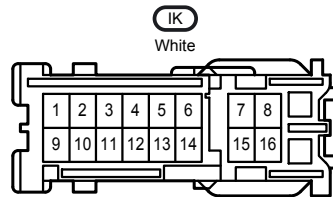
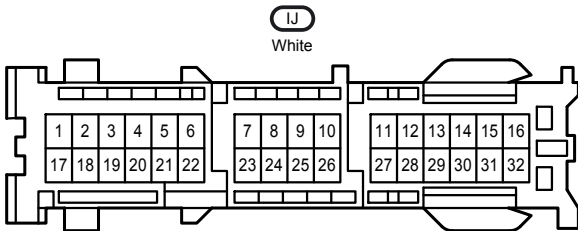
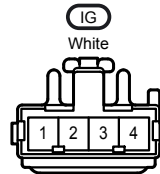
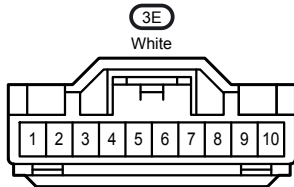
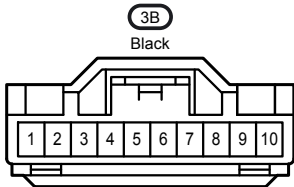
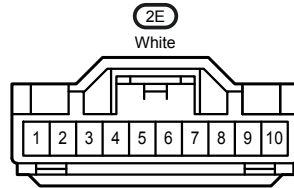
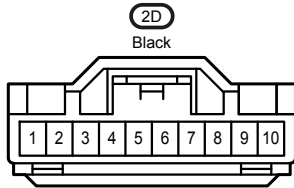
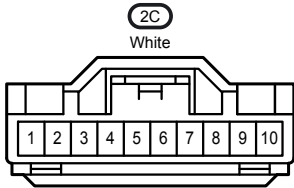
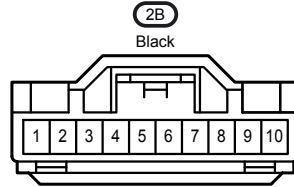
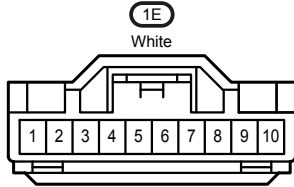
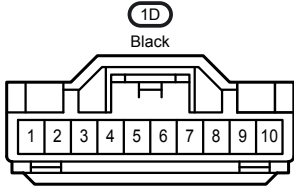
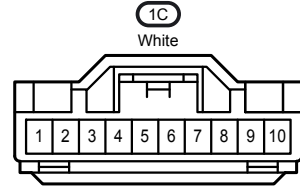
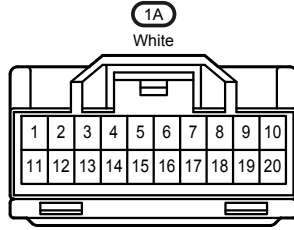
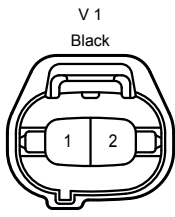
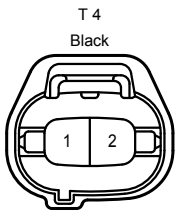

IB4
White

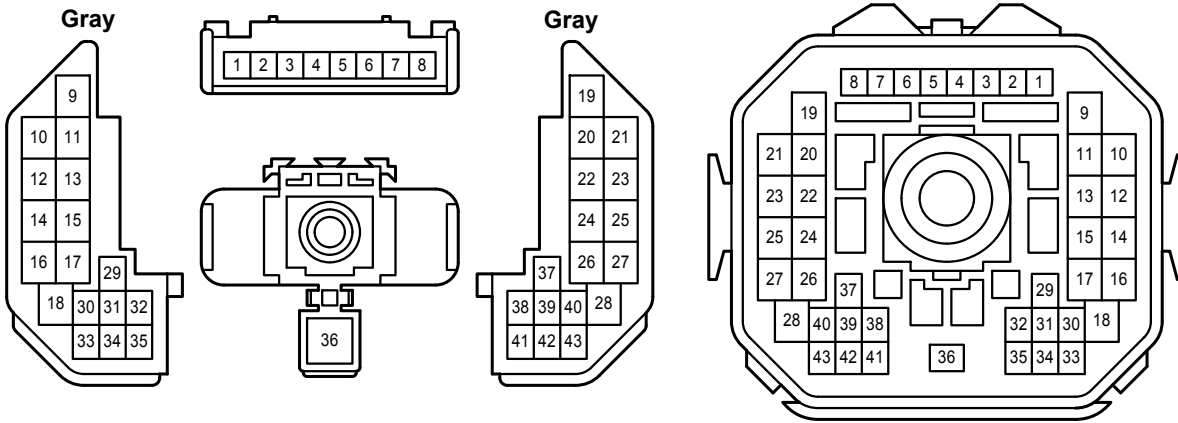

IM1
White

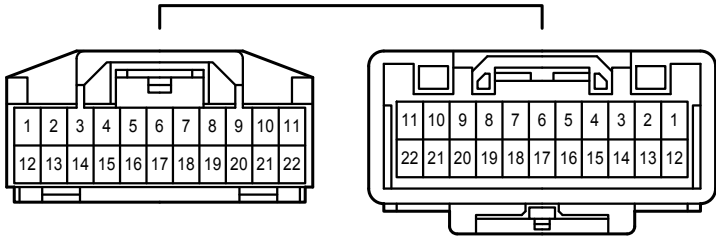

IO1
White

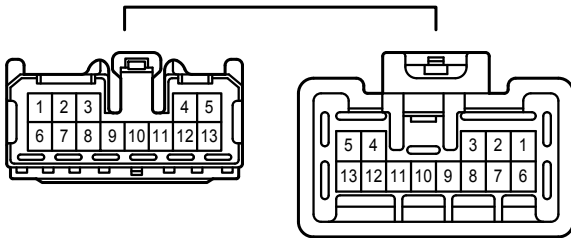

IO2
White

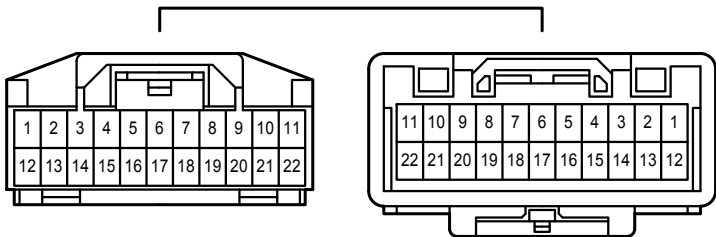

IO3
White

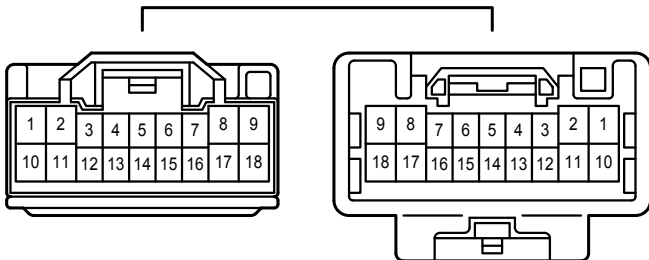

Electronically Controlled Transmission and A/T Indicator

IP3
White

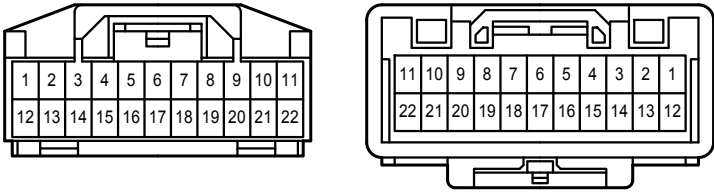

IP4
Blue

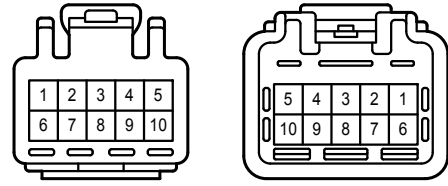

IP5
Black

